

Bestellformular / Anfrage

Ich möchte verbindlich bestellen Ich möchte ein Angebot erhalten

Rechnungsadresse

| | |
|------------------|----------------------|
| Firma* | <input type="text"/> |
| Anrede* | <input type="text"/> |
| Vorname* | <input type="text"/> |
| Nachname* | <input type="text"/> |
| Straße* | <input type="text"/> |
| PLZ* | <input type="text"/> |
| Ort* | <input type="text"/> |
| Land* | <input type="text"/> |
| Steuer ID | <input type="text"/> |
| E-Mail* | <input type="text"/> |
| Telefon* | <input type="text"/> |

Lieferadresse bitte bei abweichender Rechnungsadresse angeben

| | |
|-----------------|----------------------|
| Firma | <input type="text"/> |
| Anrede | <input type="text"/> |
| Vorname | <input type="text"/> |
| Nachname | <input type="text"/> |
| Straße | <input type="text"/> |
| PLZ | <input type="text"/> |
| Ort | <input type="text"/> |
| Land | <input type="text"/> |

Nach Erhalt des ausgefüllten Formulars, erhalten Sie eine Auftragsbestätigung / ein Angebot und weiterführenden Informationen zu Lieferzeiten und Möglichkeiten zur Übermittlung von Druckdateien. Bei uns wird DATENSCHUTZ groß geschrieben. Mehr Informationen hierzu finden Sie unter www.sela-messebau.de/de/kontakt/datenschutz.html.

* Pflichtfeld

GO LIGHTBOX

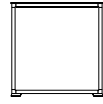

GO COUNTER

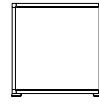

GO LIGHTBOX 100100



GO LIGHTBOX 100150



GO LIGHTBOX 085200

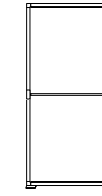

GO LIGHTBOX 100200

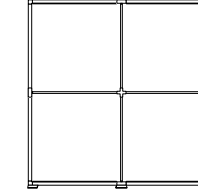

GO LIGHTBOX 200200

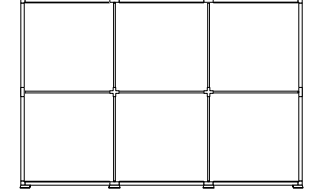

GO LIGHTBOX 300200

| B × H × T W × H × D | 1.000 × 1.000 × 150 mm | 1.000 × 1.000 × 150 mm | 1.000 × 1.500 × 150 mm | 850 × 2.000 × 150 mm | 1.000 × 2.000 × 150 mm | 2.000 × 2.000 × 150 mm | 3.000 × 2.000 × 150 mm |
|--|--|---|--|--|---|---|---|
| Artikelnummer Item NO. | #156005 | #156000 | #156001 | #156004 | #156002 | #156006 | #156007 |
| Paketinhalt* Package content* | 1 × Tasche 1 × Thekenplatte schwarz oder weiß 4 × 900 mm Profil 4 × Eckwinkel 2 × Fußplatte 6 × Verschlusskappe 2 × Systemverbinder Top 1 × Systemverbinder Step 8 × Print Clip 1 × GO LED Modul 24V 1 × ext. Netzgerät 60W-24V 1 × Gerätestecker EU 1 × Bag 1 × Tabletop black black or white 4 × 900 mm profile 4 × Corner angle 2 × Base plate 6 × Cover cap 2 × System connector top 1 × System connector step 8 × Print clip 1 × GO LED module 24V 1 × Power supply 60W-24V 1 × Device Plug EU | 1 × Tasche 4 × 900 mm Profil 4 × Eckwinkel 2 × Fußplatte 6 × Verschlusskappe 2 × Systemverbinder Top 1 × Systemverbinder Step 8 × Print Clip 1 × GO LED Modul 24V 1 × ext. Netzgerät 60W-24V 1 × Gerätestecker EU 1 × Bag 4 × 900 mm profile 4 × Corner angle 2 × Base plate 6 × Cover cap 2 × System connector top 1 × System connector step 8 × Print clip 1 × GO LED module 24V 1 × Power supply 60W-24V 1 × Device Plug EU | 1 × Tasche 2 × 900 mm Profil 4 × 650 mm Profil 4 × Eckwinkel 1 × Strebe 2 × Strebenhalter 2 × Fußplatte 6 × Verschlusskappe 2 × Systemverbinder Top 1 × Systemverbinder Step 8 × Print Clip 2 × GO LED Modul 24V 1 × ext. Netzgerät 120W-24V 1 × Gerätestecker EU 1 × Y-Kabel 1 × Bag 2 × 900 mm profile 2 × 650 mm profile 4 × Corner angle 1 × Strut 2 × Strut holder 2 × Base plate 6 × Cover cap 2 × System connector top 1 × System connector step 8 × Print clip 2 × GO LED module 24V 1 × Power supply 120W-24V 1 × Device Plug EU 1 × Y-cable | 1 × Tasche 2 × 750 mm Profil 4 × 900 mm Profil 4 × Eckwinkel 1 × Strebe 2 × Strebenhalter 2 × Fußplatte 6 × Verschlusskappe 2 × Systemverbinder Top 1 × Systemverbinder Step 8 × Print Clip 2 × GO LED Modul 24V 1 × ext. Netzgerät 120W-24V 1 × Gerätestecker EU 1 × Y-Kabel 1 × Bag 2 × 750 mm profile 4 × 900 mm profile 4 × Corner angle 1 × Strut 2 × Strut holder 2 × Base plate 6 × Cover cap 2 × System connector top 1 × System connector step 8 × Print clip 2 × GO LED module 24V 1 × Power supply 120W-24V 1 × Device Plug EU 1 × Y-cable | 1 × Tasche 6 × 900 mm Profil 4 × Eckwinkel 1 × Strebe 2 × Strebenhalter 2 × Fußplatte 6 × Verschlusskappe 2 × Systemverbinder Top 1 × Systemverbinder Step 8 × Print Clip 2 × GO LED Modul 24V 1 × ext. Netzgerät 120W-24V 1 × Gerätestecker EU 1 × Y-Kabel 1 × Bag 6 × 900 mm profile 4 × Corner angle 1 × Strut 2 × Strut holder 2 × Base plate 6 × Cover cap 2 × System connector top 1 × System connector step 8 × Print clip 2 × GO LED module 24V 1 × Power supply 120W-24V 1 × Device Plug EU 1 × Y-cable | 2 × Tasche 8 × 900 mm Profil 4 × Eckwinkel 4 × Strebe 4 × Strebenhalter 1 × Kreuzverbinder 3 × Fußplatte 6 × Verschlusskappe 2 × Systemverbinder Top 1 × Systemverbinder Step 8 × Print Clip 4 × GO LED Modul 24V 2 × ext. Netzgerät 120W-24V 2 × Gerätestecker EU 2 × Y-Kabel 1 × Verlängerungskabel 2 × Bag 8 × 900 mm profile 4 × Corner angle 4 × Strut 4 × Strut holder 1 × Cross connector 3 × Base plate 6 × Cover cap 2 × System connector top 1 × System connector step 8 × Print clip 4 × GO LED module 24V 2 × Power supply 120W-24V 2 × Device Plug EU 2 × Y-cable 1 × Extension cable | 2 × Tasche 10 × 900 mm Profil 4 × Eckwinkel 7 × Strebe 6 × Strebenhalter 2 × Kreuzverbinder 4 × Fußplatte 6 × Verschlusskappe 2 × Systemverbinder Top 1 × Systemverbinder Step 8 × Print Clip 6 × GO LED Modul 24V 3 × ext. Netzgerät 120W-24V 3 × Gerätestecker EU 3 × Y-Kabel 2 × Verlängerungskabel 2 × Bag 10 × 900 mm profile 4 × Corner angle 7 × Strut 6 × Strut holder 2 × Cross connector 4 × Base plate 6 × Cover cap 2 × System connector top 1 × System connector step 8 × Print clip 6 × GO LED module 24V 3 × Power supply 120W-24V 3 × Device Plug EU 3 × Y-cable 2 × Extension cable |
| Gewicht Weight | 11,6 kg | 8,9 kg | 11,4 kg | 11,2 kg | 12,5 kg | 20,0 kg | 29,8 kg |
| Versandgewicht Shipping weight | 12,1 kg | 9,4 kg | 11,9 kg | 11,7 kg | 13,0 kg | 21,0 kg | 30,8 kg |
| Packmaße Pack dimensions | 1.060 × 200 × 425 mm | 1.060 × 200 × 425 mm | 1.060 × 200 × 425 mm | 1.060 × 200 × 425 mm | 1.060 × 200 × 425 mm | 1.060 × 200 × 425 mm | 1.060 × 200 × 425 mm |
| Packeinheiten Pack unit | 1 | 1 | 1 | 1 | 1 | 2 | 2 |
| Preis Price | 335,00 € | 255,00 € | 442,00 € | 467,50 € | 476,00 € | 915,00 € | 1.258,00 € |
| * inkl. 2 Drucke incl. 2 prints | 400,00 € | 320,00 € | 540,00 € | 578,50 € | 606,00 € | 1.175,00 € | 1.648,00 € |

Anzahl | Quantity

* Alle LIGHTBOX Produkte verstehen sich OHNE Textilien. Textilien bitte separat bestellen.
 All LIGHTBOX products are without textiles. Please order textiles separately.

GO LIGHTBOX



GO LIGHTBOX 085225



GO LIGHTBOX 100225

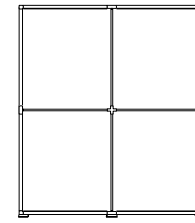

GO LIGHTBOX 200225

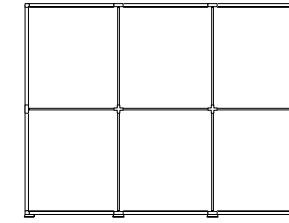

GO LIGHTBOX 300225



GO LIGHTBOX 085250

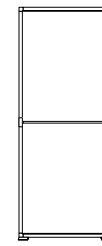

GO LIGHTBOX 100250

| B × H × T W × H × D | 850 × 2.250 × 150 mm | 1.000 × 2.250 × 150 mm | 2.000 × 2.250 × 150 mm | 3.000 × 2.250 × 150 mm | 850 × 2.500 × 150 mm | 1.000 × 2.500 × 150 mm |
|-----------------------------------|--|--|--|--|--|--|
| Artikelnummer Item NO. | #156013 | #156014 | #156015 | #156016 | #156008 | #156003 |
| Paketinhalt* Package content* | <ul style="list-style-type: none"> 1 × Tasche 2 × 750 mm Profil 4 × 1.025 mm Profil 4 × Eckwinkel 1 × Strebe 2 × Strebenhalter 2 × Fußplatte 6 × Verschlusskappe 2 × Systemverbinder Top 1 × Systemverbinder Step 8 × Print Clip 2 × GO LED Modul 24V 1 × ext. Netzgerät 120W-24V 1 × Gerätestecker EU 1 × Y-Kabel 1 × Bag 2 × 750 mm profile 4 × 1.025 mm profile 4 × Corner angle 1 × Strut 2 × Strut holder 2 × Base plate 6 × Cover cap 2 × System connector top 1 × System connector step 8 × Print clip 2 × GO LED module 24V 1 × Power supply 120W-24V 1 × Device Plug EU 1 × Y-cable | <ul style="list-style-type: none"> 1 × Tasche 2 × 900 mm Profil 4 × 1.025 mm Profil 4 × Eckwinkel 1 × Strebe 2 × Strebenhalter 2 × Fußplatte 6 × Verschlusskappe 2 × Systemverbinder Top 1 × Systemverbinder Step 8 × Print Clip 2 × GO LED Modul 24V 1 × ext. Netzgerät 120W-24V 1 × Gerätestecker EU 1 × Y-Kabel 1 × Bag 2 × 900 mm profile 4 × 1.025 mm profile 4 × Corner angle 1 × Strut 2 × Strut holder 2 × Base plate 6 × Cover cap 2 × System connector top 1 × System connector step 8 × Print clip 2 × GO LED module 24V 1 × Power supply 120W-24V 1 × Device Plug EU 1 × Y-cable | <ul style="list-style-type: none"> 2 × Tasche 4 × 900 mm Profil 4 × 1.025 mm Profil 4 × Eckwinkel 4 × Strebe 4 × Strebenhalter 1 × Kreuzverbinder 3 × Fußplatte 6 × Verschlusskappe 2 × Systemverbinder Top 1 × Systemverbinder Step 8 × Print Clip 4 × GO LED Modul 24V 2 × ext. Netzgerät 120W-24V 2 × Gerätestecker EU 2 × Y-Kabel 1 × Verlängerungskabel 2 × Bag 4 × 900 mm profile 4 × 1.025 mm profile 4 × Corner angle 4 × Strut 4 × Strut holder 1 × Cross connector 3 × Base plate 6 × Cover cap 2 × System connector top 1 × System connector step 8 × Print clip 4 × GO LED module 24V 2 × Power supply 120W-24V 2 × Device Plug EU 2 × Y-cable 1 × Extension cable | <ul style="list-style-type: none"> 2 × Tasche 6 × 900 mm Profil 4 × 1.025 mm Profil 4 × Eckwinkel 7 × Strebe 6 × Strebenhalter 2 × Kreuzverbinder 4 × Fußplatte 6 × Verschlusskappe 2 × Systemverbinder Top 1 × Systemverbinder Step 8 × Print Clip 6 × GO LED Modul 24V 3 × ext. Netzgerät 120W-24V 3 × Gerätestecker EU 3 × Y-Kabel 2 × Verlängerungskabel 2 × Bag 6 × 900 mm profile 4 × 1.025 mm profile 4 × Corner angle 7 × Strut 6 × Strut holder 2 × Cross connector 4 × Base plate 6 × Cover cap 2 × System connector top 1 × System connector step 8 × Print clip 6 × GO LED module 24V 3 × Power supply 120W-24V 3 × Device Plug EU 3 × Y-cable 1 × Extension cable | <ul style="list-style-type: none"> 1 × Tasche 2 × 750 mm Profil 4 × 1.150 mm Profil 4 × Eckwinkel 1 × Strebe 2 × Strebenhalter 2 × Fußplatte 6 × Verschlusskappe 2 × Systemverbinder Top 1 × Systemverbinder Step 8 × Print Clip 2 × GO LED Modul 24V 1 × ext. Netzgerät 120W-24V 1 × Gerätestecker EU 1 × Y-Kabel 1 × Bag 2 × 750 mm profile 4 × 1.150 mm profile 4 × Corner angle 1 × Strut 2 × Strut holder 2 × Base plate 6 × Cover cap 2 × System connector top 1 × System connector step 8 × Print clip 2 × GO LED module 24V 1 × Power supply 120W-24V 1 × Device Plug EU 1 × Y-cable | <ul style="list-style-type: none"> 1 × Tasche 2 × 900 mm Profil 4 × 1.150 mm Profil 4 × Eckwinkel 1 × Strebe 2 × Strebenhalter 2 × Fußplatte 6 × Verschlusskappe 2 × Systemverbinder Top 1 × Systemverbinder Step 8 × Print Clip 2 × GO LED Modul 24V 1 × ext. Netzgerät 120W-24V 1 × Gerätestecker EU 1 × Y-Kabel 1 × Bag 2 × 900 mm profile 4 × 1.150 mm profile 4 × Corner angle 1 × Strut 2 × Strut holder 2 × Base plate 6 × Cover cap 2 × System connector top 1 × System connector step 8 × Print clip 2 × GO LED module 24V 1 × Power supply 120W-24V 1 × Device Plug EU 1 × Y-cable |
| Gewicht Weight | 12,2 kg | 13,2 kg | 22,8 kg | 28,1 kg | 12,1 kg | 13,7 kg |
| Versandgewicht Shipping weight | 12,7 kg | 13,8 kg | 23,8 kg | 29,1 kg | 12,6 kg | 14,2 kg |
| Packmaße Pack dimensions | 1.200 × 200 × 425 mm | 1.200 × 200 × 425 mm | 1.200 × 200 × 425 mm | 1.200 × 200 × 425 mm | 1.200 × 200 × 425 mm | 1.200 × 200 × 425 mm |
| Packeinheiten Pack unit | 1 | 1 | 2 | 2 | 1 | 1 |
| Preis Price | 484,50 € | 493,00 € | 926,50 € | 1.266,50 € | 501,50 € | 510,00 € |
| * inkl. 2 Drucke incl. 2 prints | 609,50 € | 640,00 € | 1.219,50 € | 1.705,50 € | 640,50 € | 673,00 € |

Anzahl | Quantity

* Alle LIGHTBOX Produkte verstehen sich OHNE Textilien. Textilien bitte separat bestellen.
All LIGHTBOX products are without textiles. Please order textiles separately.

GO LIGHTBOX

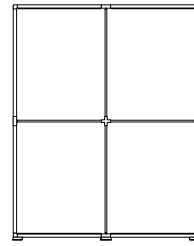

GO LIGHTBOX 200250

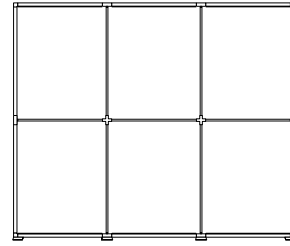

GO LIGHTBOX 300250

| B × H × T W × H × D | 2.000 × 2.500 × 150 mm | 3.000 × 2.500 × 150 mm |
|-----------------------------------|--|--|
| Artikelnummer Item NO. | #156009 | #156010 |
| Paketinhalt* Package content* | 2 × Tasche 4 × 900 mm Profil 4 × 1.150 mm Profil 4 × Eckwinkel 4 × Strebe 4 × Strebenhalter 1 × Kreuzverbinder 3 × Fußplatte 6 × Verschlusskappe 2 × Systemverbinder Top 1 × Systemverbinder Step 8 × Print Clip 4 × GO LED Modul 24V 2 × ext. Netzgerät 120W-24V 2 × Gerätestecker EU 2 × Y-Kabel 1 × Verlängerungskabel 2 × Bag 4 × 900 mm profile 4 × 1.150 mm profile 4 × Corner angle 4 × Strut 4 × Strut holder 1 × Cross connector 3 × Base plate 6 × Cover cap 2 × System connector top 1 × System connector step 8 × Print clip 4 × GO LED module 24V 2 × Power supply 120W-24V 2 × Device Plug EU 2 × Y-cable 1 × Extension cable | 2 × Tasche 6 × 900 mm Profil 4 × 1.150 mm Profil 4 × Eckwinkel 7 × Strebe 6 × Strebenhalter 2 × Kreuzverbinder 4 × Fußplatte 6 × Verschlusskappe 2 × Systemverbinder Top 1 × Systemverbinder Step 8 × Print Clip 6 × GO LED Modul 24V 3 × ext. Netzgerät 120W-24V 3 × Gerätestecker EU 3 × Y-Kabel 2 × Verlängerungskabel 2 × Bag 6 × 900 mm profile 4 × 1.150 mm profile 4 × Corner angle 7 × Strut 6 × Strut holder 2 × Cross connector 4 × Base plate 6 × Cover cap 2 × System connector top 1 × System connector step 8 × Print clip 6 × GO LED module 24V 3 × Power supply 120W-24V 3 × Device Plug EU 3 × Y-cable 1 × Extension cable |
| Gewicht Weight | 23,3 kg | 31,2 kg |
| Versandgewicht Shipping weight | 24,3 kg | 32,2 kg |
| Packmaße Pack dimensions | 1.200 × 200 × 425 mm | 1.200 × 200 × 425 mm |
| Packeinheiten Pack unit | 2 | 2 |
| Preis Price | 935,00 € | 1.275,00 € |
| * inkl. 2 Drucke incl. 2 prints | 1.260,00 € | 1.763,00 € |

Anzahl | Quantity

GO LIGHTBOX OUTDOOR

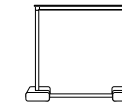

GO COUNTER OUTDOOR

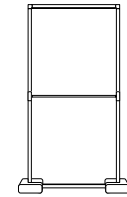

GO LIGHTBOX OUTDOOR 100200

| B × H × T W × H × D | 1.000 × 1.000 × 150 mm | 1.000 × 2.000 × 150 mm |
|----------------------------------|--|---|
| Artikelnummer Item NO. | #156011 | #156012 |
| Paketinhalt* Package content* | 1 × Tasche 1 × Thekenplatte schwarz oder weiß 4 × 900 mm Profil 4 × Eckwinkel 2 × Fußplatte 6 × Verschlusskappe 2 × Systemverbinder Top 1 × Systemverbinder Step 8 × Print Clip 1 × Outdoor LED Modul 24V 1 × ext. Netzgerät 60W-24V IP67 1 × Gerätestecker EU 2 × Sandsack 1 × Bag 1 × Tabletop black or white 4 × 900 mm profile 4 × Corner angle 2 × Base plate 6 × Cover cap 2 × System connector top 1 × System connector step 8 × Print clip 1 × Outdoor LED module 24V 1 × Power supply 60W-24V IP67 1 × Device Plug EU 2 × Sand bag | 1 × Tasche 6 × 900 mm Profil 4 × Eckwinkel 2 × Fußplatte 1 × Strebe 2 × Strebenhalter 6 × Verschlusskappe 2 × Systemverbinder Top 1 × Systemverbinder Step 8 × Print Clip 2 × Outdoor LED Modul 24V 1 × ext. Netzgerät 120W-24V IP67 1 × Gerätestecker EU 1 × Outdoor Sicherheit 1 × Bag 6 × 900 mm profile 4 × Corner angle 2 × Base plate 1 × Strut 2 × Strut holder 6 × Cover cap 2 × System connector top 1 × System connector step 8 × Print clip 1 × Outdoor LED module 24V 1 × Power supply 120W-24V IP67 1 × Device Plug EU 1 × Outdoor security |
| Gewicht Weight | 12,6 kg | 13,5 kg |
| Versandgewicht Shipping weight | 13,1 kg | 14,0 kg |
| Packmaße Pack dimensions | 1.060 × 200 × 425 mm | 1.060 × 200 × 425 mm |
| Packeinheiten Pack unit | 1 | 1 |
| Preis Price | 540,00 € | 730,00 € |
| UVP RRP | 605,00 € | 860,00 € |

Anzahl | Quantity

GO VERBINDER GO CONNECTORS

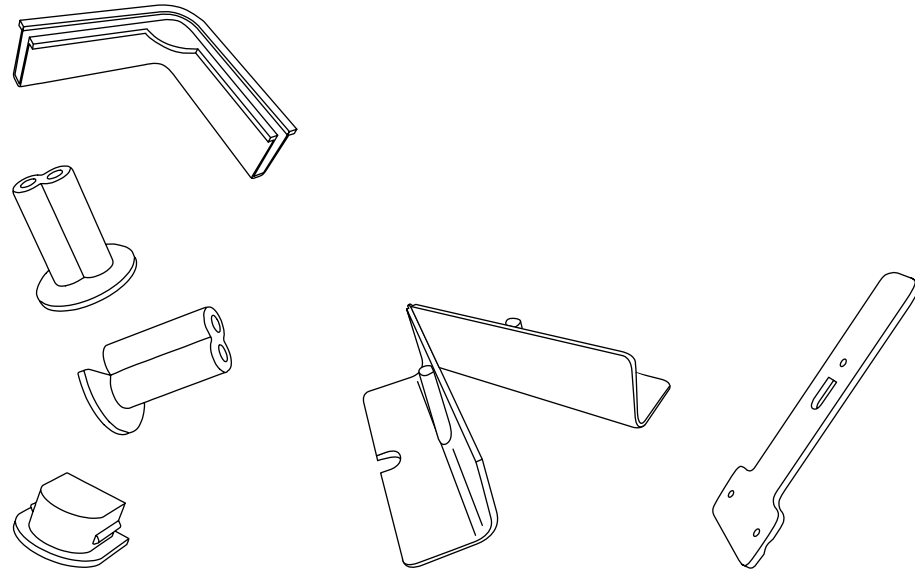

VEBRINDER SET
CONNECTOR SET

SYSTEMVERBINDER FLEX
SYSTEM CONNECTOR FLEX

T-VERBINDER
T-CONNECTOR

| | | | |
|--------------------------------------|--|--|--|
| Anwendung Application | Im Lieferumfang der LIGHTBOX Produkte enthalten. Included in the scope of delivery of LIGHTBOX products. | Element zur Verbindung gleich großer Leuchtrahmen in Winkeln bis zu 180°. Connector between lightboxes at an angle of up to 180° | Element zur Verbindung gleich großer Leuchtrahmen in T Form Connector between lightboxes in the shape of T. |
| B × H × T W × H × D | | 29,6 × 47 × 57 mm | 255 × 6 × 100 mm |
| Artikelnummer Item NO. | #352004 | #352011 | #352012 |
| Paketinhalt Package content | 6 × Verschlusskappe 2 × Systemverbinder Top 1 × Systemverbinder Step 8 × Print Clip 6 × Cover cap 2 × System connector top 1 × System connector step 8 × Print clip | 2 × Systemverbinder Flex 2 × System connector flex | 1 × Acrylscheibe 4 × Drehschraube 2 × Bolzen Gegenstück 1 × Acryl sheet 4 × Srew 2 × Bolt counterpart |
| Gesamtgewicht Total weight | 0,2 kg | 0,2 kg | 0,1 kg |
| Preis Price | 4,50 € | 17,50 € | 35,00 € |

Anzahl | Quantity

GO ZUBEHÖR GO ACCESSORIES

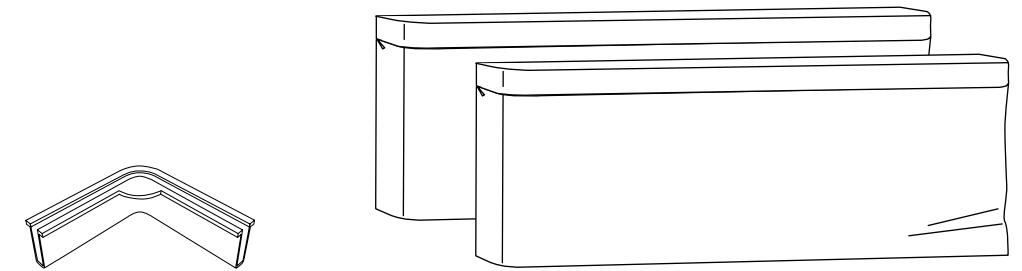

PRINT CLIP
PRINT CLIP

GO BAG 200

GO BAG 250

| | | | |
|--------------------------------------|--|---|---|
| Anwendung Application | Im Lieferumfang des Verbinder Sets enthalten. Included in the scope of delivery of the connector set. | Geeignet für alle LIGHTBOX Produkte bis 2.000 mm. Suitable for all LIGHTBOX products up to 2.000 mm. | Geeignet für alle LIGHTBOX Produkte bis 2.500 mm. Suitable for all LIGHTBOX products up to 2.500 mm. |
| B × H × T W × H × D | | 1.040 × 180 × 405 mm | 1.180 × 180 × 405 mm |
| Artikelnummer Item NO. | #352010 | #350029 | #350030 |
| Paketinhalt Package content | 40 × Print Clip 40 × Print clip | 1 × GO BAG 200 | 1 × GO BAG 250 |
| Gesamtgewicht Total weight | 0,1 kg | 1,7 kg | 2,5 kg |
| Preis Price | 7,50 € | 29,90 € | 45,00 € |

Anzahl | Quantity

* Alle LIGHTBOX Produkte verstehen sich OHNE Textilien. Textilien bitte separat bestellen.
All LIGHTBOX products are without textiles. Please order textiles separately.

GO ZUBEHÖR GO ACCESSORIES

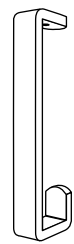

DECKENABHÄNGUNG SET
CEILING SUSPENSION SET

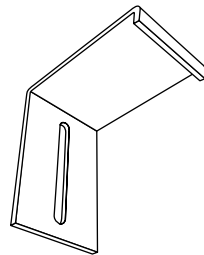

WANDMONTAGE SET
WALL MOUNTING SET

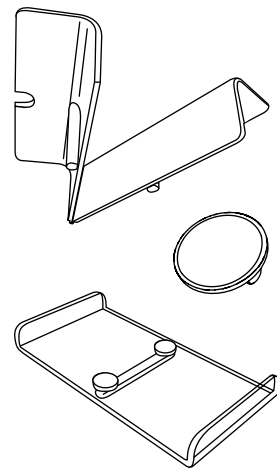

TÜR SET
DOOR SET

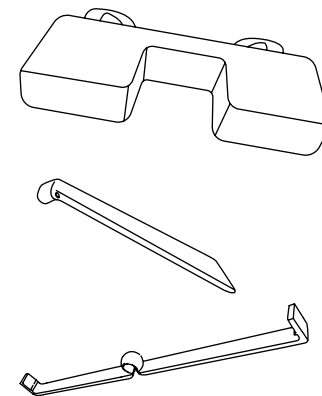

OUTDOOR SICHERUNG
OUTDOOR PROTECTION

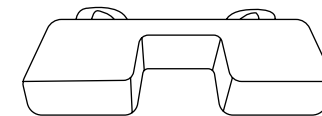

OUTDOOR SANDSACK
OUTDOOR SAND BAG

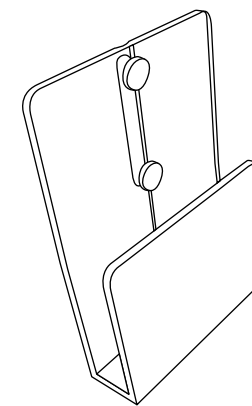

PROSPEKTHALTER
BROCHURE HOLDER

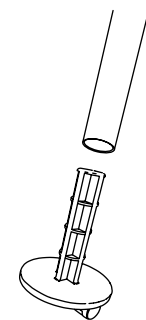

FAHNEN SET
BANNER SET

| | | | | | | | |
|--------------------------------------|--|---|---|--|---|---|---|
| Anwendung Application | Montageset zur Abhängung eines Leuchtrahmens von der Decke Assembly set to suspend a frame from the ceiling | Montageset zur Befestigung eines Rahmens an der Wand Assembly kit to mount a frame at the wall | Montageset zur Errichtung einer funktionsfähigen Tür Assembly kit for the door construction | Set zur Stabilisierung der Leuchtkästen im Outdoorbereich Set for the safe installation of a outdoor frame | Sandsack zur Stabilisierung der Leuchtkästen im Outdoorbereich Sandsack for the safe installation of a outdoor frame | Prospekthalter für Prospekte und Flyer jeder Größe Prospect holder for prospects and flyers of any size | Der Fahnenstoff ist nicht im Lieferumfang enthalten. → S.19 The banner is not included with delivery. → p.19 |
| B × H × T W × H × D | 120 × 92 × 25 mm | 50 × 78 × 78 mm | | | 600 × 40 × 250 mm | 150 × 210 × 50 mm | 400 × 800 mm |
| Artikelnummer Item NO. | #352021 | #352022 | #352005 | #352023 | #352024 | #352020 | #352014 |
| Paketinhalt Package content | 4 × Deckenmontagewinkel 4 × Ceiling mounting angle | 4 × Wandmontagewinkel 4 × Wall mounting angle | 2 × Systemverbinder Flex 1 × Türgriff 2 × Türgleiter 2 × System connector flex 1 × Door handle 2 × Door glides | 2 × Sandsack leer 2 × Abspannseile 4 × Bodenanker 8 × Drucksicherung 2 × Sand bag empty 2 × Guy rope 4 × Ground anchor 8 × Textile protection | 2 × Sandsack leer 2 × San bag empty | 1 × Prospekthalter Acryl 1 × Aluschlitten 100 mm 2 × Rändelschraube 1 × Prospect holder Acryl 1 × Alu slide 100 mm 2 × Knurled screw | 1 × Fahnenstange 400 mm 1 × Fahnenstange 800 mm 1 × Fahnenhalter 1 × Fahnenecke 90° 1 × Flag pole 400 mm 1 × Flag pole 800 mm 1 × Banner holder 1 × Mounting angle 90° |
| Gesamtgewicht Total weight | 0,1 kg | 0,1 kg | 0,8 kg | 0,4 kg | 0,8 kg | 0,3 kg | 0,2 kg |
| Preis Price | 40,00 € | 54,00 € | 56,00 € | 98,00 € | 61,20 € | 48,50 € | 27,50 € |

Anzahl | Quantity

GO ZUBEHÖR GO ACCESSORIES

RAHMENFARBE FRAME COLOR

Anwendung | Application Individuelle Pulverbeschichtung in RAL Tönen
Individual powder coating in RAL tones

| Größe Size | GO COLOR 100100 | GO COLOR 100150 |
|--------------------------|-----------------|-----------------|
| Artikelnummer Item NO. | #352100 | #352101 |
| Preis Price | 112,00 € | 168,00 € |

Anzahl | Quantity

| Größe Size | GO COLOR 085200 | GO COLOR 085225 | GO COLOR 085250 |
|--------------------------|-----------------|-----------------|-----------------|
| Artikelnummer Item NO. | #352104 | #352113 | #352108 |
| Preis Price | 168,00 € | 168,00 € | 168,00 € |

Anzahl | Quantity

| Größe Size | GO COLOR 100200 | GO COLOR 100225 | GO COLOR 100250 |
|--------------------------|-----------------|-----------------|-----------------|
| Artikelnummer Item NO. | #352102 | #352114 | #352103 |
| Preis Price | 168,00 € | 168,00 € | 168,00 € |

Anzahl | Quantity

| Größe Size | GO COLOR 200200 | GO COLOR 200225 | GO COLOR 200250 |
|--------------------------|-----------------|-----------------|-----------------|
| Artikelnummer Item NO. | #352106 | #352115 | #352109 |
| Preis Price | 224,00 € | 224,00 € | 224,00 € |

Anzahl | Quantity

| Größe Size | GO COLOR 300200 | GO COLOR 300225 | GO COLOR 300250 |
|--------------------------|-----------------|-----------------|-----------------|
| Artikelnummer Item NO. | #352107 | #352116 | #352110 |
| Preis Price | 336,00 € | 336,00 € | 336,00 € |

Anzahl | Quantity

SEITENBLENDE SIDE LABEL

Paketinhalt | Package content Zwei individuell bedruckbare
Seitenblende für die Rahmen
Two individual printed side label
for the frame

| | |
|--------------------------|----------------|
| B × H W × H | 1.000 × 150 mm |
| Artikelnummer Item NO. | #352015 |
| Preis Price | 34,00 € |

Anzahl | Quantity

| | |
|--------------------------|----------------|
| B × H W × H | 1.500 × 150 mm |
| Artikelnummer Item NO. | #352017 |
| Preis Price | 38,00 € |

Anzahl | Quantity

| | |
|--------------------------|----------------|
| B × H W × H | 2.000 × 150 mm |
| Artikelnummer Item NO. | #352018 |
| Preis Price | 48,00 € |

Anzahl | Quantity

| | |
|--------------------------|----------------|
| B × H W × H | 2.250 × 150 mm |
| Artikelnummer Item NO. | #352016 |
| Preis Price | 51,00 € |

Anzahl | Quantity

| | |
|--------------------------|----------------|
| B × H W × H | 2.500 × 150 mm |
| Artikelnummer Item NO. | #352019 |
| Preis Price | 55,00 € |

Anzahl | Quantity

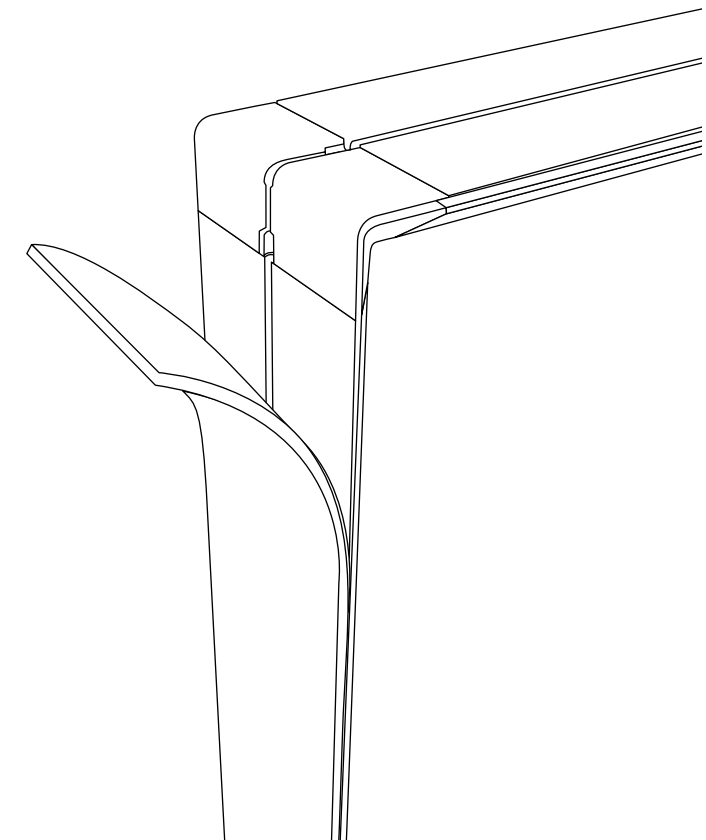

GO TEXTILIEN

GO TEXTILES

| | 1.000 × 1.000 mm | 1.000 × 1.500 mm | 850 × 2.000 mm | 1.000 × 2.000 mm | 2.000 × 2.000 mm | 3.000 × 2.000 mm |
|---|----------------------------------|----------------------------------|----------------------------------|----------------------------------|----------------------------------|----------------------------------|
| B × H W × H | 1.000 × 1.000 mm | 1.000 × 1.500 mm | 850 × 2.000 mm | 1.000 × 2.000 mm | 2.000 × 2.000 mm | 3.000 × 2.000 mm |
| Gewicht Weight | 0,4 kg | 0,7 kg | 0,7 kg | 0,9 kg | 1,7 kg | 2,6 kg |
| PRINT LIGHT SUB <small>Textil inkl. Druck zur Hinterleuchtung Textile incl. print for backlit</small> | PRINT LIGHT SUB 100100 | PRINT LIGHT SUB 100150 | PRINT LIGHT SUB 085200 | PRINT LIGHT SUB 100200 | PRINT LIGHT SUB 200200 | PRINT LIGHT SUB 300200 |
| Artikelnummer Item NO. | #255000 | #255001 | #255004 | #255002 | #255006 | #255007 |
| Preis Price | 32,50 € | 49,00 € | 55,50 € | 65,00 € | 130,00 € | 195,00 € |

Anzahl | Quantity

| | | | | | | |
|--|---------------------------------|---------------------------------|---------------------------------|---------------------------------|---------------------------------|---------------------------------|
| PRINT LIGHT UV <small>Textil inkl. Druck zur Hinterleuchtung Textile incl. print for backlit</small> | PRINT LIGHT UV 100100 | PRINT LIGHT UV 100150 | PRINT LIGHT UV 085200 | PRINT LIGHT UV 100200 | PRINT LIGHT UV 200200 | PRINT LIGHT UV 300200 |
| Artikelnummer Item NO. | #252000 | #252001 | #252004 | #252002 | #252006 | #252007 |
| Preis Price | 32,50 € | 49,00 € | 55,50 € | 65,00 € | 130,00 € | 195,00 € |

Anzahl | Quantity

| | | | | | | |
|--|------------------------------|------------------------------|------------------------------|------------------------------|------------------------------|------------------------------|
| WHITE LIGHT <small>Textil ohne Druck zur Hinterleuchtung Textile without print for backlit</small> | WHITE LIGHT 100100 | WHITE LIGHT 100150 | WHITE LIGHT 085200 | WHITE LIGHT 100200 | WHITE LIGHT 200200 | WHITE LIGHT 300200 |
| Artikelnummer Item NO. | #251000 | #251001 | #251004 | #251002 | #251006 | #251007 |
| Preis Price | 32,50 € | 49,00 € | 55,50 € | 65,00 € | 130,00 € | 195,00 € |

Anzahl | Quantity

| | | | | | | |
|---|------------------------------|------------------------------|------------------------------|------------------------------|------------------------------|------------------------------|
| PRINT BLOCK <small>Blickdichtes Textil inkl. Druck Opaque textile incl. print</small> | PRINT BLOCK 100100 | PRINT BLOCK 100150 | PRINT BLOCK 085200 | PRINT BLOCK 100200 | PRINT BLOCK 200200 | PRINT BLOCK 300200 |
| Artikelnummer Item NO. | #254000 | #254001 | #254004 | #254002 | #254006 | #254007 |
| Preis Price | 40,00 € | 60,00 € | 68,00 € | 80,00 € | 160,00 € | 240,00 € |

Anzahl | Quantity

| | | | | | | |
|--|------------------------------|------------------------------|------------------------------|------------------------------|------------------------------|------------------------------|
| WHITE BLOCK <small>Blickdichtes Textil ohne Druck Opaque textile without print</small> | WHITE BLOCK 100100 | WHITE BLOCK 100150 | WHITE BLOCK 085200 | WHITE BLOCK 100200 | WHITE BLOCK 200200 | WHITE BLOCK 300200 |
| Artikelnummer Item NO. | #253000 | #253001 | #253004 | #253002 | #253006 | #253007 |
| Preis Price | 32,50 € | 49,00 € | 55,50 € | 65,00 € | 130,00 € | 195,00 € |

Anzahl | Quantity

GO TEXTILIEN

GO TEXTILES

| | 850 × 2.250 mm | 1.000 × 2.250 mm | 2.000 × 2.250 mm | 3.000 × 2.250 mm | 850 × 2.500 mm | 1.000 × 2.500 mm |
|---|----------------------------------|----------------------------------|----------------------------------|----------------------------------|----------------------------------|----------------------------------|
| B × H W × H | 850 × 2.225 mm | 1.000 × 2.225 mm | 2.000 × 2.25 mm | 3.000 × 2.225 mm | 850 × 2.500 mm | 1.000 × 2.500 mm |
| Gewicht Weight | 0,8 kg | 1,0 kg | 1,9 kg | 3,0 kg | 0,9 kg | 1,1 kg |
| PRINT LIGHT SUB <small>Textil inkl. Druck zur Hinterleuchtung Textile incl. print for backlit</small> | PRINT LIGHT SUB 085225 | PRINT LIGHT SUB 100225 | PRINT LIGHT SUB 200225 | PRINT LIGHT SUB 300225 | PRINT LIGHT SUB 085250 | PRINT LIGHT SUB 100250 |
| Artikelnummer Item NO. | #255013 | #255014 | #255015 | #255016 | #255008 | #255003 |
| Preis Price | 62,50 € | 73,50 € | 146,50 € | 219,50 € | 69,50 € | 81,50 € |

Anzahl | Quantity

| | | | | | | |
|--|---------------------------------|---------------------------------|---------------------------------|---------------------------------|---------------------------------|---------------------------------|
| PRINT LIGHT UV <small>Textil inkl. Druck zur Hinterleuchtung Textile incl. print for backlit</small> | PRINT LIGHT UV 085225 | PRINT LIGHT UV 100225 | PRINT LIGHT UV 200225 | PRINT LIGHT UV 300225 | PRINT LIGHT UV 085250 | PRINT LIGHT UV 100250 |
| Artikelnummer Item NO. | #252013 | #252014 | #252015 | #252016 | #252008 | #252003 |
| Preis Price | 62,50 € | 73,50 € | 146,50 € | 219,50 € | 69,50 € | 81,50 € |

Anzahl | Quantity

| | | | | | | |
|--|------------------------------|------------------------------|------------------------------|------------------------------|------------------------------|------------------------------|
| WHITE LIGHT <small>Textil ohne Druck zur Hinterleuchtung Textile without print for backlit</small> | WHITE LIGHT 085225 | WHITE LIGHT 100225 | WHITE LIGHT 200225 | WHITE LIGHT 300225 | WHITE LIGHT 085250 | WHITE LIGHT 100250 |
| Artikelnummer Item NO. | #251013 | #251014 | #251015 | #251016 | #251008 | #251003 |
| Preis Price | 62,50 € | 73,50 € | 146,50 € | 219,50 € | 69,50 € | 81,50 € |

Anzahl | Quantity

| | | | | | | |
|---|------------------------------|------------------------------|------------------------------|------------------------------|------------------------------|------------------------------|
| PRINT BLOCK <small>Blickdichtes Textil inkl. Druck Opaque textile incl. print</small> | PRINT BLOCK 085225 | PRINT BLOCK 100225 | PRINT BLOCK 200225 | PRINT BLOCK 300225 | PRINT BLOCK 085250 | PRINT BLOCK 100250 |
| Artikelnummer Item NO. | #254013 | #254014 | #254015 | #254016 | #254008 | #254003 |
| Preis Price | 76,50 € | 90,00 € | 180,00 € | 270,00 € | 85,00 € | 100,00 € |

Anzahl | Quantity

| | | | | | | |
|--|------------------------------|------------------------------|------------------------------|------------------------------|------------------------------|------------------------------|
| WHITE BLOCK <small>Blickdichtes Textil ohne Druck Opaque textile without print</small> | WHITE BLOCK 085225 | WHITE BLOCK 100225 | WHITE BLOCK 200225 | WHITE BLOCK 300225 | WHITE BLOCK 085250 | WHITE BLOCK 100250 |
| Artikelnummer Item NO. | #253013 | #253014 | #253015 | #253016 | #253008 | #253003 |
| Preis Price | 62,50 € | 73,50 € | 146,50 € | 219,50 € | 69,50 € | 81,50 € |

Anzahl | Quantity

GO TEXTILIEN GO TEXTILES

| | 2.000 × 2.500 mm | 3.000 × 2.500 mm |
|---|----------------------------------|----------------------------------|
| B × H W × H | 2.000 × 2.500 mm | 3.000 × 2.500 mm |
| Gewicht Weight | 2,2 kg | 3,3 kg |
| PRINT LIGHT SUB <small>Textil inkl. Druck zur Hinterleuchtung Textile incl. print for backlit</small> | PRINT LIGHT SUB 200250 | PRINT LIGHT SUB 300250 |
| Artikelnummer Item NO. | #255009 | #255010 |
| Preis Price | 162,50 € | 244,00 € |

Anzahl | Quantity

| | | |
|--|---------------------------------|---------------------------------|
| PRINT LIGHT UV <small>Textil inkl. Druck zur Hinterleuchtung Textile incl. print for backlit</small> | PRINT LIGHT UV 200250 | PRINT LIGHT UV 300250 |
| Artikelnummer Item NO. | #252009 | #252010 |
| Preis Price | 162,50 € | 244,00 € |

Anzahl | Quantity

| | | |
|--|------------------------------|------------------------------|
| WHITE LIGHT <small>Textil ohne Druck zur Hinterleuchtung Textile without print for backlit</small> | WHITE LIGHT 200250 | WHITE LIGHT 300250 |
| Artikelnummer Item NO. | #251009 | #251010 |
| Preis Price | 162,50 € | 244,00 € |

Anzahl | Quantity

| | | |
|---|------------------------------|------------------------------|
| PRINT BLOCK <small>Blickdichtes Textil inkl. Druck Opaque textile incl. print</small> | PRINT BLOCK 200250 | PRINT BLOCK 300250 |
| Artikelnummer Item NO. | #254009 | #254010 |
| Preis Price | 200,00 € | 300,00 € |

Anzahl | Quantity

| | | |
|--|------------------------------|------------------------------|
| WHITE BLOCK <small>Blickdichtes Textil ohne Druck Opaque textile without print</small> | WHITE BLOCK 200250 | WHITE BLOCK 300250 |
| Artikelnummer Item NO. | #253009 | #253010 |
| Preis Price | 162,50 € | 244,00 € |

Anzahl | Quantity

| | FAHNENSTOFF BANNER |
|---------------------------------|-----------------------|
| B × H W × H | 400 × 600 mm |
| Gewicht Weight | < 0,1 kg |
| Artikelnummer Item NO. | #259000 |
| Preis Price | 22,00 € |

Anzahl | Quantity